



# X1 Series User Manual

0.7kw - 2.0kw



EN



## Solax Power Network Technology(Zhe jiang) Co., Ltd.

No.288 Shizhu Road, Tonglu Economic Development Zone,  
Tonglu City, Zhejiang province, China.

Tel: +86 0571-56260011

E-mail: info@solaxpower.com

### Copyright Declaration

The copyright of this manual belongs to Solax Power Network Technology(Zhe jiang) Co., Ltd. Any corporation or individual should not plagiarize, partially or fully copy (including software, etc.), and no reproduction or distribution of it in any form or by any means. All rights reserved. Solax Power Network Technology (Zhe jiang) Co., Ltd. reserves the right of final interpretation.

## Contents

1 Note on this Manual .....	03
1.1 Scope of Validity .....	03
1.2 Target Group .....	03
1.3 Symbols Used .....	03
2 Safety .....	04
2.1 Appropriate Usage .....	04
2.2 Important Safety Instructions .....	06
2.3 PE Connection and Leakage Current .....	08
2.4 Explanation of Symbols .....	09
2.5 CE Directives .....	10
3 Introduction .....	11
3.1 Basic Features .....	11
3.2 Terminals of the Inverter .....	12
3.3 Dimension .....	13
4 Technical Data .....	14
4.1 DC Input .....	14
4.2 AC Output .....	14
4.3 Efficiency, Safety and Protection .....	15
4.4 General Data .....	15
5 Installation .....	16
5.1 Check for Transport Damage .....	16
5.2 Packing Lists .....	16
5.3 Installation Precaution .....	17
5.4 Installation Steps .....	18
5.5 Connections of the Inverter .....	19
5.6 Run the Inverter .....	29
6 Operation Method .....	30
6.1 Control Panel .....	30
6.2 LCD Structure .....	31
6.3 LCD Operation .....	32

7 Troubleshooting ..... 37  
 7.1 Troubleshooting ..... 37  
 7.2 Routine Maintenance ..... 40

8 Decommissioning ..... 41  
 8.1 Dismantling the Inverter ..... 41  
 8.2 Packaging ..... 41  
 8.3 Storage and Transportation ..... 41

# 1 Notes on this Manual

## 1.1 Scope of Validity

This manual is an integral part of X1 Series. It describes the assembly, installation, commissioning, maintenance and failure of the product. Please read it carefully before operating.

X1-0.7-S-D (L)	X1-1.1-S-D (L)	X1-1.5-S-D (L)	X1-2.0-S-D (L)
X1-0.7-S-N (L)	X1-1.1-S-N (L)	X1-1.5-S-N (L)	X1-2.0-S-N (L)

Note: **“0.7”** means 0.7kW. **“S”** means “single” or one MPPT string. **“D”** means with “DC Switch”, **“N”** means without “DC Switch”. **“L”** means with “LCD display”.

Keep this manual at where is accessible all the time.

## 1.2 Target Group

This manual is for qualified electricians. The tasks described in this manual only can be performed by qualified electricians.

## 1.3 Symbols Used

The following types of safety instructions and general information appear in this document as described below:

	<b>DANGER!</b> “Danger” indicates a hazardous situation which, if not avoided, will result in death or serious injury.
--	---

	<b>WARNING!</b> “Warning” indicates a hazardous situation which, if not avoided, could result in death or serious injury.
---	--

	<b>CAUTION!</b> “Caution” indicates a hazardous situation which, if not avoided, could result in minor or moderate injury.
---	---

	<b>NOTE!</b> “Note” provides tips that are valuable for the optimal operation of your product.
---	---

## 2 Safety

### 2.1 Appropriate Usage

The X1 Series are PV inverters which can convert the DC current of the PV generator into AC current and feed it into the public grid.

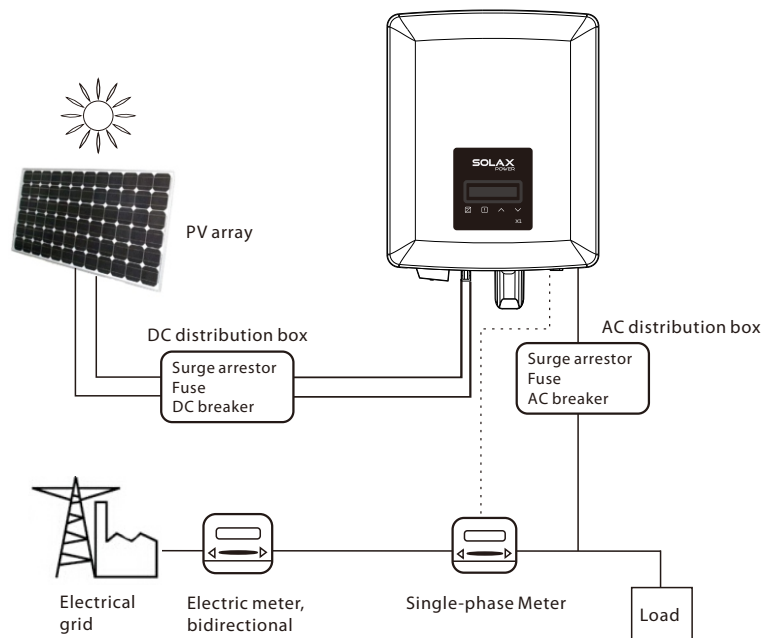

### ► Surge protection devices (SPDs) for PV installation



**WARNING !**

- Over-voltage protection with surge arresters should be provided when the PV power system is installed.
- The grid connected inverter is fitted with SPDs in both PV input side and MAINS side.

Lightning will cause a damage either from a direct strike or from surges due to a nearby strike.

Induced surges are the most likely cause of lightning damage in majority of installations, especially in rural areas where electricity is usually provided by long overhead lines. Surge may be included on both the PV array conduction and the AC cables leading to the building.

Specialists in lightning protection should be consulted during the end use application. Using appropriate external lightning protection, the effect of a direct lightning strike into a building can be mitigated in a controlled way, and the lightning current can be discharged into the ground.

Installation of SPDs to protect the inverter against mechanical damage and excessive stress include a surge arrester in case of a building with external lightning protection system (LPS) when separation distance is kept.

To protect the DC system, surge suppression device (SPD type2) should be fitted at the inverter end of the DC cabling and at the array located between the inverter and the PV generator, if the voltage protection level (VP) of the surge arresters is greater than 1100V, an additional SPD type 3 required for surge protection for electrical devices.

To protect the AC system, surge suppression devices (SPD type2) should be fitted at the main incoming point of AC supply (at the consumer's cutout), located between the inverter and the meter/distribution system; SPD (test impulse D1) for signal line according to EN 61632-1.

All DC cables should be installed to provide as short a run as possible, and positive and negative cables of the string or main DC supply should be bundled together. Avoid creating loops in the system. This requirement for short runs and bundling includes any associated earth bundling conductors.

Spark gap devices are not suitable to be used in DC circuits once conducting, they won't stop conducting until the voltage passes through their terminals typically less than 30 volts.

### ► Anti-Islanding Effect

Islanding effect is a special phenomenon that grid-connected PV system still supply power to the nearby grid when the voltage loss is happened in the power system. It is dangerous for maintenance personnel and the public.

X1 series provide Active Frequency Drift(AFD) to prevent islanding effect.

## 2.2 Important Safety Instructions



### DANGER!

#### Danger to life due to high voltages in the inverter!

- All work must be carried out by qualified electrician.
- The appliance is not to be used by children or persons with reduced physical sensory or mental capabilities, or lack of experience and knowledge, unless they have been given supervision or instruction.
- Children should be supervised to ensure that they do not play with the appliance.



### CAUTION!

#### Danger of burn injuries due to hot enclosure parts!

- During operation, the upper lid of the enclosure and the enclosure body may become hot.
- Only touch the lower enclosure lid during operation.



### CAUTION!

#### Possible damage to health as a result of the effects of radiation!

- Do not stay closer than 20 cm to inverter for any length of time.



### NOTE!

#### Grounding the PV generator!

- Comply with the local requirements for grounding the PV modules and the PV generator. SolaX recommends connecting the generator frame and other electrically conductive surfaces in a manner which ensures continuous conduction and ground these in order to have optimal protection of system and persons.



### WARNING!

- Ensure input DC voltage  $\leq$  Max. DC voltage. Over voltage may cause permanent damage to inverter or other losses, which will not be included in warranty!



### WARNING!

- Authorized service personnel must disconnect both AC and DC power from X1 series before attempting any maintenance or cleaning or working on any circuits connected to the X1 series.



### WARNING!

Do not operate the inverter when the device is running.



### WARNING!

Risk of electric shock!

- Prior to the application, please read this section carefully to ensure correct and safe application. Please keep the user manual properly.
- Use only attachments recommended or sold by SolaX. Otherwise may result in a risk of fire, electric shock, or injury to person.
- Make sure that existing wiring is in good condition and that wire is not undersized.
- Do not disassemble any parts of inverter which are not mentioned in installation guide. It contains no user-serviceable parts. See Warranty for instructions on obtaining service. Attempting to service the X1 Series inverter yourself may result in a risk of electric shock or fire and will void your warranty.
- Keep away from flammable, explosive materials to avoid fire disaster.
- The installation place should be away from humid or corrosive substance.
- Authorized service personnel must use insulated tools when installing or working with this equipment.
- PV modules shall have an IEC 61730 class A rating.
- Never touch either the positive or negative pole of PV connecting device. Strictly prohibit touching both of them at the same time.
- The unit contains capacitors that remain charged to a potentially lethal voltage after the MAINS and PV supply has been disconnected.
- Hazardous voltage will present for up to 5 minutes after disconnection from power supply.
- CAUTION-RISK of electric shock from energy stored in capacitor. Never operate on the solar inverter couplers, the MAINS cables, PV cables or the PV generator when power is applied. After switching off the PV and Mains, always wait for 5 minutes to let the intermediate circuit capacitors discharge before you unplug DC and MAINS couplers.
- When accessing the internal circuit of solar inverter, it is very important to wait 5 minutes before operating the power circuit or demounting the electrolyte capacitors inside the device. Do not open the device before hand since the capacitors require time to sufficiently discharge!
- Measure the voltage between terminals UDC+ and UDC- with a multi-meter (impedance at least 1Mohm) to ensure that the device is discharged before beginning work (35VDC) inside the device.

### 2.3 PE Connection and Leakage Current

- The inverter incorporates a certified internal Residual Current Device (RCD) in order to protect against possible electrocution and fire hazard in case of a malfunction in the cables or the inverter. There are two trip thresholds for the RCD as required for certification (IEC 62109-2:2011). The default value for electrocution protection is 30mA, and for slow rising current is 300mA.
- If an external RCD is required by local regulations, check which type of RCD is required for relevant electric code. It recommends using a type-A RCD. The recommended RCD values is 100mA or 300mA unless a lower value is required by the specific local electric codes. When required by local regulations, the use of an RCD type B is permitted.

The device is intended to connect to a PV generator with a capacitance limit of approx 700nf.



	<p><b>WARNING !</b></p> <ul style="list-style-type: none"> <li>• High leakage current!</li> <li>• Earth connection essential before connecting supply.</li> </ul>
---	---

- Incorrect grounding can cause physical injury, death or equipment malfunction and increase electromagnetic.
  - Make sure that grounding conductor is adequately sized as required by safety regulations.
  - Do not connect the ground terminals of the unit in series in case of a multiple installation. This product can cause current with a d.c component, Where a residual current operated protective (RCD) or monitoring (RCM) device is used for protection in case of direct or indirect contact, only one RCD or RCM of type B is allowed on the supply side of this product.
- **For United Kingdom**
- The installation that connects the equipment to the supply terminals shall comply with the requirements of BS 7671.
  - Electrical installation of PV system shall comply with requirements of BS 7671 and IEC 60364-7-712.
  - No protection settings can be altered.
  - Installer shall ensure that equipment is so installed and operated to maintain at all times compliance with the requirements of ESQCR22(1)(a).
- **For Australia and New Zealand**
- Electrical installation and maintenance shall be conducted by licensed electrician and shall comply with Australia National Wiring Rules.











### 2.4 Explanation of Symbols

This section gives an explanation of all the symbols shown on the inverter and on the type label.

• Symbols on the Inverter

Symbol	Explanation
	When the blue light is on, it indicates the inverter is working normally.
	When the red light is on, it indicates an error has occurred.

• Symbols on the Type Label

Symbol	Explanation
	CE mark. The inverter complies with the requirements of the applicable CE guidelines.
	RCM remark.
	SAA certification.
	Beware of hot surface. The inverter can become hot during operation. Avoid contact during operation.
	Danger of high voltages. Danger to life due to high voltages in the inverter!
	Danger. Risk of electric shock!
	Observe enclosed documentation.
	The inverter can not be disposed together with the household waste. Disposal information can be found in the enclosed documentation.
	Do not operate this inverter until it is isolated from mains and on-site PV generation suppliers.
	Danger to life due to high voltage. There is residual voltage in the inverter which needs 5 min to discharge. • Wait 5 min before you open the upper lid or the DC lid.

## 2.5 CE Directives

This chapter follows the requirements of the European low voltage directives, which contains the safety instructions and conditions of acceptability for the end user system, which you must follow when installing, operating and servicing the unit. If ignored, physical injury or death may follow, or damage may occur to the unit. Read this instructions before you work on the unit. If you are unable to understand the dangers, warnings, cautions or instructions, please contact an authorized service dealer before installing, operating and servicing the unit.

The Grid connected inverter meets the requirement stipulated in Low Voltage Directive (LVD) 2014/35/EU and Electromagnetic Compatibility (EMC) Directive 2014/30/EU. The unit is based on:

EN 62109-1:2010; EN 62109-2:2011; IEC 62109-1(ed.1); IEC62109-2(ed.1); EN 61000-6-3:2007+A:2011; EN 61000-6-1:2007; EN 61000-6-2:2005.

In case of installation in PV system, startup of the unit (i.e. start of designated operation) is prohibited until it is determined that the full system meets the requirements stipulated in EC Directive (2014/35/EU,2014/30/EU, etc.)

The grid connected inverter leave the factory completely connecting device and ready for connection to the mains and PV supply ,the unit shall be installed in accordance with national wiring regulations. Compliance with safety regulations depends upon installing and configuring system correctly, including using the specified wires. The system must be installed only by professional assemblers who are familiar with requirements for safety and EMC. The assembler is responsible for ensuring that the end system complies with all the relevant laws in the country where it is to be used.

The individual subassembly of the system shall be interconnected by means of the wiring methods outlined in national/international such as the national electric code (NFPA) No.70 or VDE regulation 0107.

## 3 Introduction

### 3.1 Basic Features

Thanks for your purchasing with SolaX X1 Series inverter. The X1 Series inverter is one of the finest inverters on the market today, incorporating state-of-the-art technology, high reliability, and convenient control features.

- Advanced DSP control technology.
- Utilize the latest high-efficiency power component.
- Optimal MPPT technology.
  - One MPP Tracking.
  - Wide MPPT input range.
- Advanced anti-islanding solutions.
- IP65 protection level.
- Max. efficiency up to 97.1%. EU efficiency up to 96.5%.
- THD<3%.
- Safety & Reliability: transformerless design with software and hardware protection.
- Power factor regulation.
- Friendly HMI.
  - LED status indications.
  - LCD display technical data, Human-machine interaction through press key.
  - Dry contact communication interface.
  - PC remote control.
  - Remote upgrade and upgrade through USB interface.
  - Pocket Wi-Fi/LAN/GPRS monitoring.
  - Energy conservation.

### 3.2 Terminals of the Inverter

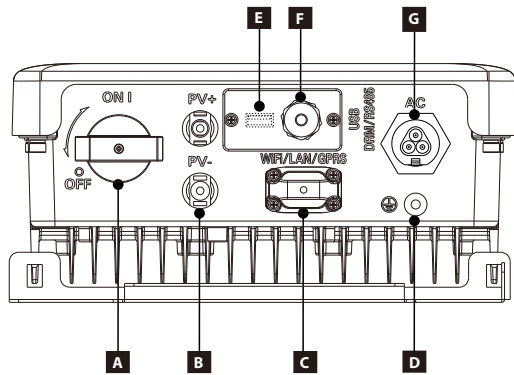

Object	Description
A	DC Switch (optional)
B	DC Connector
C	Pocket WiFi/LAN/GPRS
D	Ground screw
E	USB for Upgrade
F	RS 485/ Meter/ DRM
G	AC Connector



#### WARNING!

Only authorized personnel is allowed to set the connection.

### 3.3 Dimension

#### ➤ Dimension

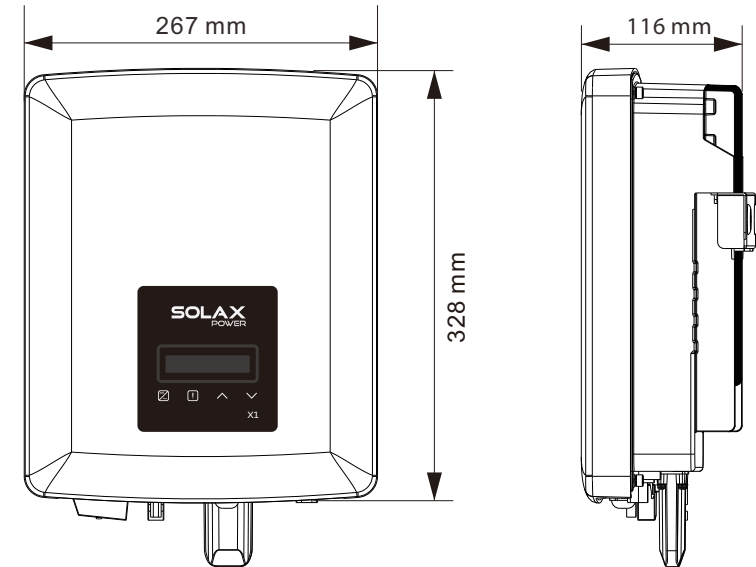

#### ➤ Weight

Model	X1-0.7-S-D (L)	X1-1.1-S-D (L)	X1-1.5-S-D (L)	X1-2.0-S-D (L)
	X1-0.7-S-N (L)	X1-1.1-S-N (L)	X1-1.5-S-N (L)	X1-2.0-S-N (L)
Net Weight	6Kg	6Kg	6Kg	6Kg
Gross Weight	8Kg	8Kg	8Kg	8Kg



## 4. Technical Data

### 4.1 DC Input

Model	X1-0.7-S-D (L)	X1-1.1-S-D (L)	X1-1.5-S-D (L)	X1-2.0-S-D (L)
	X1-0.7-S-N (L)	X1-1.1-S-N (L)	X1-1.5-S-N (L)	X1-2.0-S-N (L)
Max. DC power [W]	840	1250	1650	2200
Max. DC voltage[V]	400	400	400	400
Norminal DC operating voltage[V]	360	360	360	360
MPPT voltage range [V]	55-380	55-380	55-380	55-380
MPPT voltage range@full load [V]	70-350	110-350	150-350	200-350
Max. input current [A]	10	10	10	10
Max. short circuit current [A]	12	12	12	12
MAX. inverter backfeed current to the array [A]	0	0	0	0
Start input voltage [V]	60	60	60	60
Start output voltage [V]	70	70	70	70
No. of MPP trackers	1	1	1	1
Strings per MPP tracker	1	1	1	1
DC disconnection switch	Optional			

### 4.2 AC Output

Model	X1-0.7-S-D (L)	X1-1.1-S-D (L)	X1-1.5-S-D (L)	X1-2.0-S-D (L)
	X1-0.7-S-N (L)	X1-1.1-S-N (L)	X1-1.5-S-N (L)	X1-2.0-S-N (L)
Rated output power [W]	700	1100	1500	2000
Max.apparent AC power [VA]	700	1100	1500	2000
Rated grid voltage and range [V]	220/230/240;180-280V			
Rated AC frequency and range [Hz]	50/60; ±5Hz			
Nominal AC current [A]	3.04	4.78	6.52	8.70
Max. output current [A]	3.5	5.5	7.5	9.5
Max. output fault current [A]	18	18	18	18
Max. output overcurrent protection [A]	65	65	65	65
Inrush current [A]	75	75	75	75
Output	L/N/PE	L/N/PE	L/N/PE	L/N/PE
Total harmonic distortion(THDi)	<3%	<3%	<3%	<3%
Displacement power factor	0.8leading-0.8lagging			

### 4.3 Efficiency, Safety and Protection

Model	X1-0.7-S-D (L)	X1-1.1-S-D (L)	X1-1.5-S-D (L)	X1-2.0-S-D (L)
	X1-0.7-S-N (L)	X1-1.1-S-N (L)	X1-1.5-S-N (L)	X1-2.0-S-N (L)
MPPT efficiency	99.90%	99.90%	99.90%	99.90%
Euro efficiency	95.00%	95.50%	96.00%	96.50%
Max. efficiency	97.10%	97.10%	97.10%	97.10%
<b>Safety &amp; Protection</b>				
Over/under voltage protection	YES			
DC isolation protection	YES			
Monitoring ground fault protection	YES			
Grid protection	YES			
DC injection monitoring	YES			
Back feed current monitoring	YES			
Residual current detection	YES			
Anti-islanding protection	YES			
Over load protection	YES			
Over heat protection	YES			

### 4.4 General Data

Model	X1-0.7-S-D (L)	X1-1.1-S-D (L)	X1-1.5-S-D (L)	X1-2.0-S-D (L)
	X1-0.7-S-N (L)	X1-1.1-S-N (L)	X1-1.5-S-N (L)	X1-2.0-S-N (L)
Dimension [W/H/D](mm)	267*328*116			
Dimension of packing [W/H/D](mm)	406*328*187			
Net weight [kg]	6	6	6	6
Gross weight [kg]	8	8	8	8
Installation	Wall-mounted			
Operating temperature range[°C]	-25~+60 (derating at 45)			
Storage temperature [°C]	-25~+60			
Storage/Operation relative humidity	0%~100%, condensation			
Altitude [m]	≤2000			
Ingress Protection	IP65			
Night-time consumption	<1w			
Cooling	Natural			
Noise level	<25dB			
Inverter topology	Transformerless			
Pollution degree	II			
Communication interface	RS485/ Wi-Fi(optional) /Meter(optional)/ USB/ DRM			
Standard warranty [year]	5years (10 optional)			

## 5. Installation

### 5.1 Check for Transport Damage

Make sure the inverter is intact during transportation. If there are some visible damages, such as cracks, please contact your dealer immediately.

### 5.2 Packing Lists

Open the package and fetch out the product, check the accessories at first. The packing list shows as below.

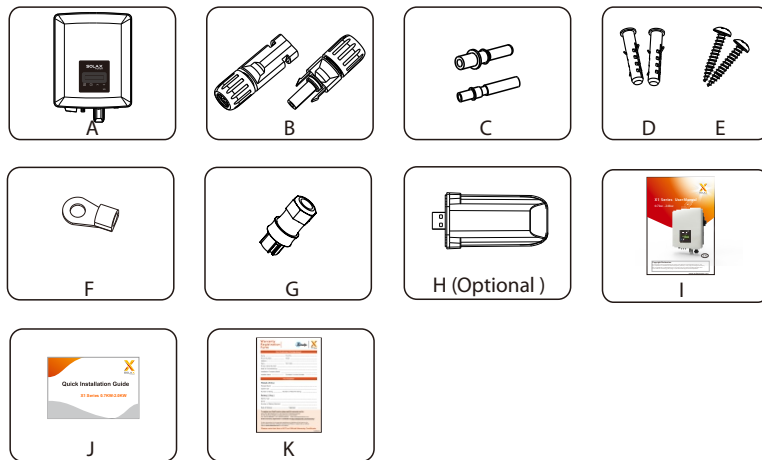

Object	Quantity	Description
A	1	X1 series inverter
B	2	DC connector
C	2	DC pin contact(1*positive, 1*negative)
D	2	Expansion tube
E	2	Expansion screw
F	1	Earth terminal
G	1	AC connector
H	1	Pocket WiFi/LAN/GPRS( Optional )
I	1	Product manual
J	1	Quick installation guide
K	1	Warranty card

### 5.3 Installation Precaution

X1 Series inverter is designed for outdoor installation (IP 65). Make sure the installation site meets the following conditions:

- Not be exposed to glare.
- Not in areas where highly flammable materials are stored.
- Not in potential explosive areas.
- Not in the cool air directly.
- Not near the television antenna or antenna cable.
- Not higher than altitude of about 2000m above sea level.
- Not in environment of precipitation or humidity(100%) .
- Be sure the ventilation is good enough.
- The ambient temperature in the range of -25℃ to +60℃.
- The slope of the wall should be within  $\pm 5^\circ$  .
- The wall hanging the inverter should meet conditions below:
  - 1) Solid brick/concrete, or strength equivalent mounting surface;
  - 2) Inverter must be supported or strengthened if the wall's strength isn't enough(such as wooden wall, the wall covered by thick layer of decoration)

Please avoid direct sunlight, rain exposure, snow laying up during installing and operating.

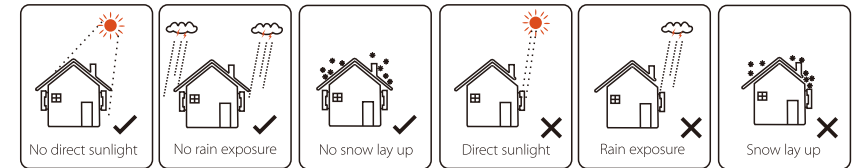

#### ➤ Available Space Size

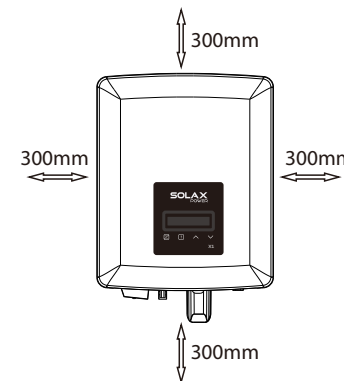

Table2 Available Space Size

Position	Min.size
Left	300mm
Right	300mm
Top	300mm
Bottom	300mm
Front	300mm

### 5.4 Installation Steps

➤ Preparation

Below tools are needed before installation.



Installation tools: crimping pliers for binding post , screwdriver, manual wrench and Φ10 driller.

➤ Step 1: Unscrew the bracket from the back of the inverter.

a) The wall bracket is fixed on the inverter, and the user should remove it firstly. (Φ10 driller.torque:  $0.8 \pm 0.1\text{Nm}$ )

➤ Step 2: Screw the wall bracket on the wall

- b) Use the wall bracket as a template to mark the position of the 3 holes on the wall.
- c) Drill holes with driller, make sure the holes are deep enough (at least 50mm) for installation, and then tighten the expansion tubes.
- d) Install the expansion tubes in the holes, and tighten them. Then install the wall bracket by using the expansion screws.(Φ10 driller.torque:  $0.8 \pm 0.1\text{Nm}$ )

➤ Step 3: Match the inverter with wall bracket

e) Hang the inverter over the bracket, move the inverter close to it, slightly lay down the inverter, and make sure the 3 mounting bars on the back are fixed well with the 3 grooves on the bracket.

Note: Please refer to the details from the Quick Installation Guide.

### 5.5 Connections of the Inverter

#### 5.5.1 The Main Steps to Connect to the Inverter

➤ PV String Connection

The inverter has one-string PV connector. Please select PV modules with excellent function and reliable quality. Open circuit voltage of module array connected should be  $< \text{Max.DC}$  (table as follow) input voltage, and operating voltage should be within the MPPT voltage range.

Table3 Max. DC Voltage Limitation

Model	X1-0.7-S-D (L)	X1-1.1-S-D (L)	X1-1.5-S-D (L)	X1-2.0-S-D (L)
	X1-0.7-S-N (L)	X1-1.1-S-N (L)	X1-1.5-S-N (L)	X1-2.0-S-N (L)
<b>Max.DC Voltage</b>	400V			

**DANGER!**  
Danger to life due to high voltages on DC conductors.

- When exposed to sunlight, the PV array generates dangerous DC voltage which is present in the DC conductors. Touching the DC conductors can lead to lethal electric shocks.
- Cover the PV modules.
- Do not touch the DC conductors.

**WARNING!**  
PV module voltage is very high which belongs to dangerous voltage range, please comply with the electric safety rules when connecting.

**WARNING!**  
Please do not make PV positive or negative ground!

**NOTE!**  
Please follow the requirements of PV modules as below:

- Same type; Same quantity; Identical alignment; Identical tilt.
- In order to save cable and reduce the DC loss, we suggest installing the inverter near PV modules.

● Connection Steps

Below tools are needed before connection.



- a) Turn off the DC switch, then Choose 12 AWG wire to connect the PV module.
- b) Trip 7mm of insulation from the wire end by using the stripping pliers.

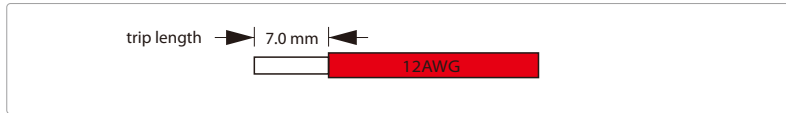

- c) Insert striped wire into pin contact and ensure all conductor strand are captured in the pin contact.

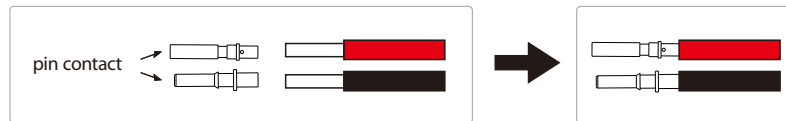

- d) Crimp pin contact by using the wire crimper.

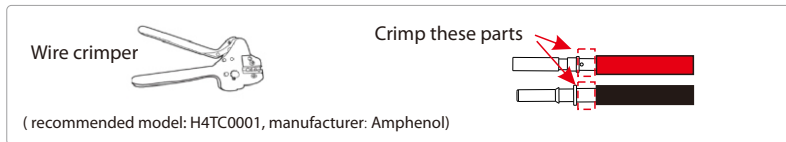

- e) Separate the DC connector as two parts: the plug and the cable nut. Then insert the wire with pin contact through the cable nut.

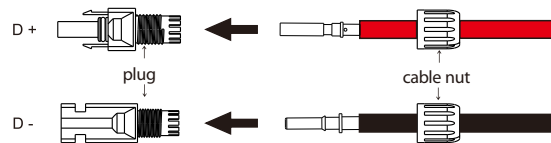

- f) Insert the wire into plug forcibly, when a "click" is heard or felt the pin contact assembly is seated correctly. Then tighten the cable nut.



➤ Grid Connection

X1 series inverter are designed for single phase grid. Voltage range is 220/230/240V, frequency is 50/60Hz. Other technical requests should comply with the requirement of the local public grid.

Table 4 Cable and Micro-breaker recommended

Model	X1-0.7-S-D (L) X1-0.7-S-N (L)	X1-1.1-S-D (L) X1-1.1-S-N (L)	X1-1.5-S-D (L) X1-1.5-S-N (L)	X1-2.0-S-D (L) X1-2.0-S-N (L)
Cable	12AWG	12AWG	12AWG	12AWG
Micro-breaker	10A	10A	10A	16A

\*The parameters have some differences because of different environment and material. Please according to the local conditions to choose appropriate cable and micro-breaker.

Micro-breaker should be installed between inverter and grid, any loads should not be connected with inverter directly.

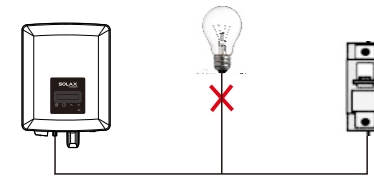

**Incorrect Connection between Load and Inverter**

Impedance of X1 series Inverter AC connecting dot should be less than  $2\Omega$ . To ensure reliable anti-islanding function, PV cable should be used to ensure wire loss < 1% than normal power. Moreover, length between AC side and grid connecting dot should be less than 150m. The following chart is the cable length, section area and wire loss.

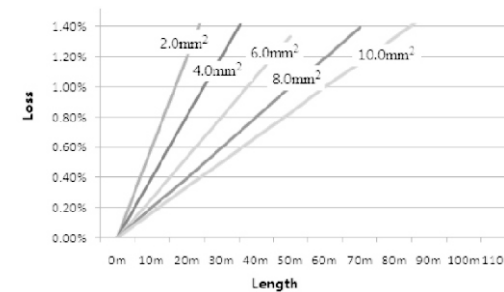

This product has a professional IP65 AC waterproof connector. You have to wire AC by yourself. Please see the figure below.

### • Connection Steps

- Check the grid voltage and compare with the permissive voltage range (refer to technical data).
- Disconnect the circuit-breaker from all the phases and secure against re-connection.
- Trip the wires:
  - Trip all the wires to 52.5mm and the PE wire to 55mm.
  - Use the crimping pliers to trip 6mm of insulation from AI wire ends as below.

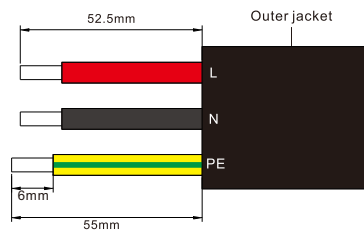

- Separate the AC plug into three parts as below.
  - Hold the middle part of the female insert, rotate the back shell to loose it, and detach it from female inset.
  - Remove the cable nut (with rubber insert) from the back shell.



- Slide the cable nut and then back shell onto the cable.

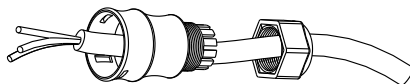

- Insert the tripped end of each three wires into the appropriate hole in the female insert, and then tight each screw (to tight each wire in place).(PH1 cross screwdriver .torque: $0.8 \pm 0.1\text{Nm}$ )



- Screw down the threaded sleeve of the pressure screw.

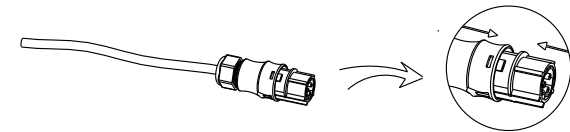

- Screw down the pressure screw.(torque: $3 \pm 0.3\text{Nm}$ )

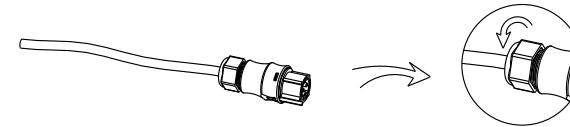

- Connect the AC plug to the inverter.

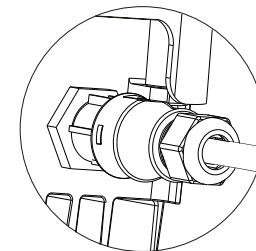

➤ **Earth Connection**

Screw the ground screw with allen wrench shown as follow. ( $\phi$  4 hexagon wrench.torque:1.5±0.2Nm)

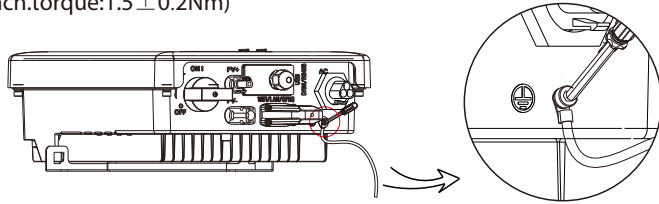

**WARNING!**  
Be sure the ground wire must be connected!

**5.5.2 Communication interface**

This product has a series of communication interfaces: such as WiFi, RS485/Mete/ DRM and USB for upgrading for human and machine communication. Operating information like output voltage, current, frequency, faulty information, etc., can be delivered to PC or other monitoring equipment via these interfaces.

① **WiFi**

This inverter provides a WiFi port which can collect information from inverter including status, performance and updating information to monitoring website via connecting Pocket WiFi( purchase the product from supplier if needed)

Connection steps:

1. Plug the Pocket WiFi into “WiFi/LAN/GPRS” port at the bottom of inverter.
2. Connect the WiFi with router.
3. Set the station account on the SolaX web. (Please check the Pocket WiFi user manual for more details) (torque:0.6±0.1Nm)

② **RS 485/Meter/DRM**

a. RS 485

RS 485 is one standard communication interface which can transmit the real data from inverter to PC or other monitoring equipments.

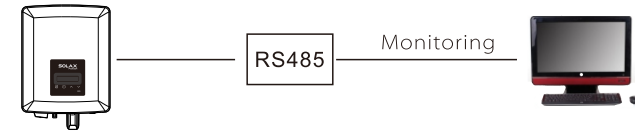

b. Meter(optional)

With this single phase meter working together with the X1 series, you can:  
 (1) Monitor the energy to grid and from grid through the whole day.  
 (2) Achieve the export control function with a higher accuracy.

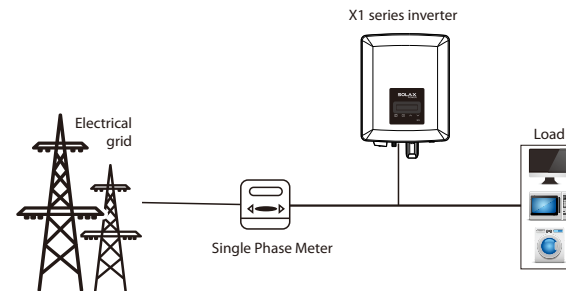

The PIN definitions of RS 485/Meter interface are as below.

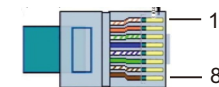

PIN	1	2	3	4	5	6	7	8
Definition	RefGen	Com/DRM0	GND_COM	Meter_A/ 485_A	Meter_B/ 485_B	E_Stop	GND_COM	X

➤ RS 485 Connection Steps:

- 1) Firstly unscrew the screw from the 485 port.(PH1 cross screwdriver .torque: $0.8 \pm 0.1$  Nm)
- 2) Prepare a communication cable and trip the insulation from it.
- 3) Let the communication cable pass through the waterproof connector, then insert it into the connector following the PIN definition rule.

Hand tighten. torque:  $1.2 \pm 0.1$  Nm

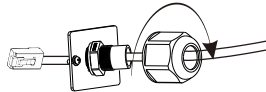

- 4) Crimp the connector with the crimping plier.
- 5) Insert the cable into the 485 port of the inverter, and tighten the waterproof connector.

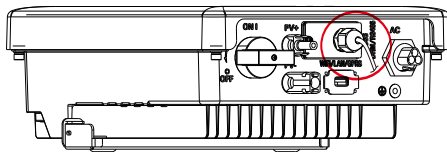

➤ Meter Connection Steps:

Please see the Quick Guide and User Manual for Single Phase Meter Installation for details.

③ DRM

DRM function (for AS4777) is provided to support several demand response modes by giving control signals as below. The user should short circuit between 1 and 2 and cooperate with external equipment when using it.

DRM shares the terminal block with RS485/Meter communications. The connection steps of the DRM, user can refer to the above RS485 connections.

Note: Only DRM0 is available now, and other functions are being developed.

④ Upgrade

User can update the inverter system through the USB flash driver.



**WARNING!**

Make sure the input voltage is more than 100V (in good illumination condition), otherwise it may result in failing during updating.

➤ Upgrade Steps:

- 1) Please contact our service support to get the update file, and extract it into your USB flash driver as the following file path:

```
"update\ARM\618.00207.00_X1_BOOST3.0_MINI2.0_AIR2.0_ARM_Vx.xx_XXXXXXX.usb";
"update\DSP\618.00205.00_X1_BOOST3.0_MINI2.0_AIR2.0_DSP_Vx.xx_XXXXXXX.usb"
```

Note: Vx.xx is version number, XXXXXXX is file completion date.



**WARNING!**

- Make sure the directory is in accordance with above form strictly!
- Do not modify the program file name ! Otherwise it may cause the inverter not work anymore !

- 2) Make sure the DC switch is off and the AC is disconnected with grid.

- 3) Insert USB flash drive with update program into the USB port on the bottom of the inverter. Turn on DC switch or connect the PV connector.

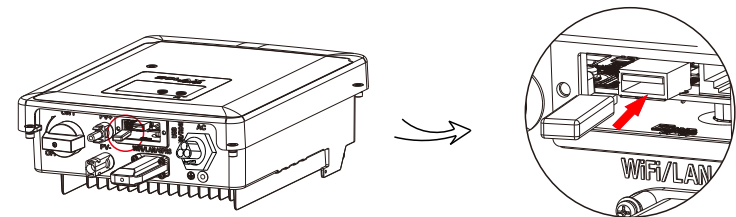

4) Short press up and down key to select the one that you want to update and long press down key to confirm.

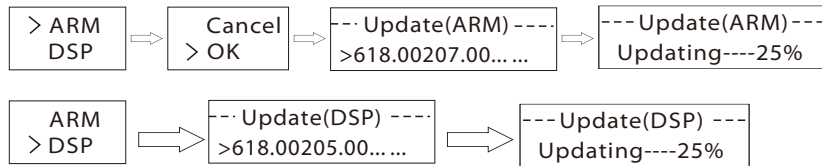

5) After the upgrade is complete, please remember to turn off the DC switch or disconnect the PV connector, then pull off the USB flash dirver, screw the panel of USB port.

**WARNING!**



During updating, please don't turn off the DC switch or disconnect the PV connector. If failed, please repeat the above operation again.

**⑤ Isolation Fault Alarm**

The isolation fault alarm installed into the inverter, is the standard configuration, as required by AS 4777.2 and AS/NZS 5033, it will give an alarm once the isolation impedance of the PV arrays is less than 100KΩ .

**5.6 Run the Inverter**

- Start inverter after checking all below steps:
  - a) Check that device is fixed well on the wall.
  - b) Make sure all the DC breakers and AC breakers are disconnected.
  - c) AC cable is connected to grid correctly.
  - d) All PV panels are connected to inverter correctly, DC connectors which are not used should be sealed by cover.
  - e) Turn on the external AC and DC connectors.
  - f) Turn on the DC switch to the "ON" position.

- Start the inverter
  - a) Inverter will start automatically when PV panels generate enough energy.
  - b) Check the status of LED indication and LCD screen, the LED indication should be blue and the LCD screen should display the main interface.
  - c) If the LED indication is not blue, please check the below:
    - All the connections are right.
    - All the external disconnect switches are closed.
    - The DC switch of the inverter is in the "ON" position.

- Below is the three status when operating, which means inverter starting up successfully.

Waiting: Inverter is waiting to checking when DC input voltage from panels is greater than 60V (lowest start-up voltage) but less than 70V (lowest operating voltage).

Checking: Inverter will check DC input environment automatically when DC input voltage from the PV panels exceeds 70V and PV panels have enough energy to start inverter.

Normal: Inverter begins to operate normally with blue light on. Meanwhile feedback energy to grid, LCD displays present output power.

Enter the setting interface to follow the instructions when it is first time to start up.

**WARNING!**



Power to the unit must be turned on only after installation work has been completed. All electrical connections must be carried out by qualified personnel in accordance with legislation in force in the country concerned.

**NOTE!**



Please set the inverter if it is the first time to start up. Above steps are for the regular start of the inverter. If it is the first time to start up the inverter, you need to setup the inverter.

**ENERGY CONTROL**



Equipment only to be used for the purpose outlined by SolaX.



## 6. Operation Method

### 6.1 Control panel

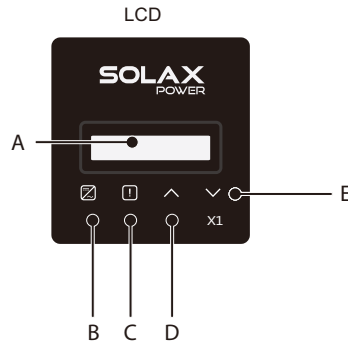

Object	Name	Description
A	LCD Screen	Display the information of the inverter.
B	Indicator LED	Light in blue: The inverter is in normal status. Flash in blue: The inverter is in waiting status.
C		Light in red: The inverter is in fault status.
D	Function Button	Up/ESC button: Move cursor to upside or increase value. Return from current interface or function
E		Down/Enter button: Move cursor to downside or decrease value. Confirm and change the parameters.

Note: When the inverter is in "Waiting" and "Checking" status, the blue light "B" is flickering; when in "Normal" status, the blue light "B" is always on.

### 6.2 LCD Structure

Please refer to the inverter for the most updated structure

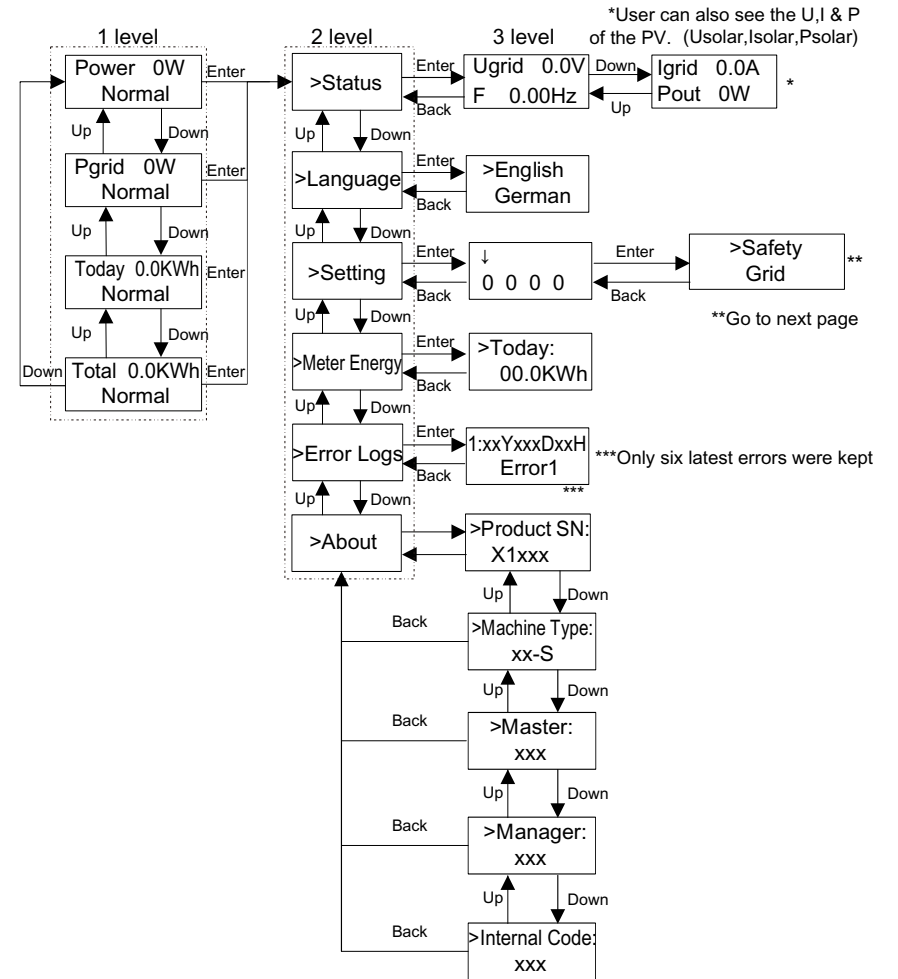

**Note:**

Key	Operation	Description
V Enter/Down	Long Press	Go to the next menu or confirm to change parameters
	Short Press	Look at the next parameter or increase the value
^ Back/Up	Long Press	Return the previous menu or confirm the parameters
	Short Press	Look at the previous parameter or decrease the value

### 6.3 LCD Operation

- Setting function is used for setting the inverter for Safety, Grid, Power Factor and so on.
- Since this function will change the inverter's parameter, the end user with the user password as "0000" has the limited authority to change the setting. We need installer password to do most of the professional setting.

\*\*Previous page

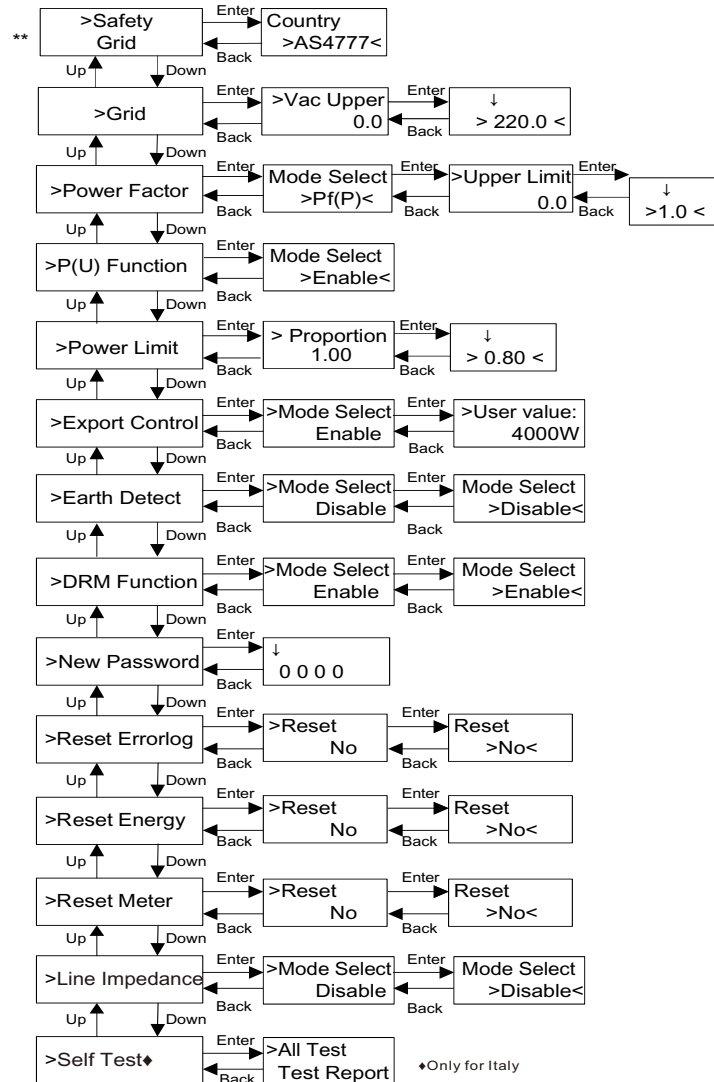

### ➤ LCD Display

- Level 1
  - a) The first line displays the parameters(Power, Pgrid Today and Total) and the values.
  - b) The second line shows the running status.  
 Namely, "Power" means the timely output power;  
 "Pgrid" means the power export to or import from the grid; (Positive value means the energy feeds into grid, negative value means the energy used from the grid)  
 "Today" means the power generated within the day.  
 "Normal" means the status of the inverter.

- Level 2  
 Long press any first-level parameter can enter the second-level "Status" parameter interface.  
 User can also see other parameters, such as the Language( without password ), Setting ( need password ), Meter energy(including Today, Today Import, Today Export, Today Total), Error Logs of the inverter, and About ( the user can watch the information of the inverter).

- Level 3  
 Long press the second-level parameter can enter the corresponding third-level parameter interface.
  - a) Status: The user can see the U/I/P parameters of the grid and the PV, such as the Ugrid, Igrid, P and F of the grid, and the Usolar, Isolar and Psolar of the PV.
  - b) Language: This inverter provides several languages for customer to choose.
  - c) Setting: Entering the installer password, the information of the LCD interface is as the previous page shown.
    - (1) Safety: The user can set the right safety standard here.
    - (2) Grid: Usually end user do not need to set the grid parameters. All default value have been set before leaving factory according to safety rules.

If need to reset, any changes should according to the requirement of local grid.

Parameter	Comment
Normally	
Vac upper	Voltage high protect
Vac lower	Voltage low protect
Vac upper slow	Voltage high slow protect
Vac lower slow	Voltage low slow protect
Fac upper	Frequency high protect
Fac lower	Frequency low protect
Fac upper slow	Frequency high slow protect
Fac lower slow	Frequency low slow protect
Vac 10m avg	10 min voltage high protect
Apply to EN50549_NL / VDE 4105	
FreqSetPoint	Frequency set point
FreqDropRate	Frequency droop rate
Apply to VDE 4105	
Q_3Tau	Reactive response time

(3) Power Factor: ( For specific country if required by the local grid.)  
 There are 6 modes for selecting: Off , Under-Excited, Over-Excited, PF(p), Q( u ).  
 All parameters are shown below.

Mode	Comment
Off	-
Under-Excited	PF value
Over-Excited	PF value
PF(p)	Upper limit
	Lower limit
	Power Upper
	Power Lower
Q( u )	QuVupRate ( EN50549_NL )
	QuVlowRate ( EN50549_NL )
	QUrangV1 ( AS4777.2 )
	QUrangV4 ( AS4777.2 )
Fixed Q Power	Q Power( for some local grids )

For VDE ARN 4105, curve  $\cos \varphi = f(P)$  should refer to curve A. default values of setting are as shown in curve A.  
 For E 8001, curve  $\cos \varphi = f(P)$  should refer to curve B. default values of setting are as shown in curve B.

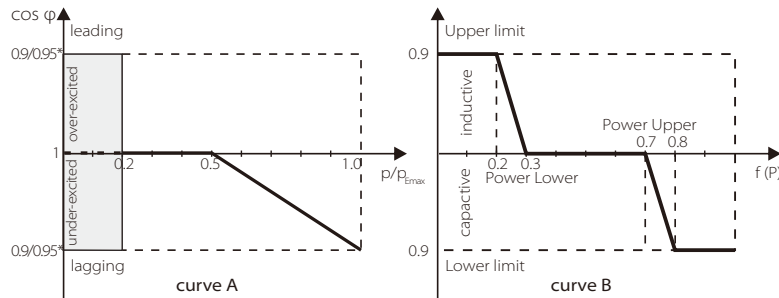

Reactive power control, Reactive standard curve  $Q = f(V)$

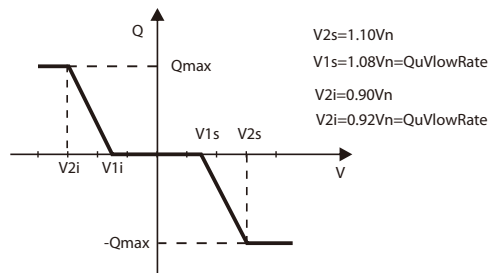

→The way to operate the value :  
 a) Just watch the parameter of the mode by short pressing (A) and (V) .  
 b) If you change other mode by short pressing (A) and (V) , you need return the Power Factor interface by long pressing the (V). Then short press (V) to confirm and enter the Upper Limit. This time you can modify the value by long pressing (A) ; If you only change the parameter of the mode(default), you just long press the (A) to modify the value.  
 c) After setting, long press the (V) key to confirm and return the previous directly.

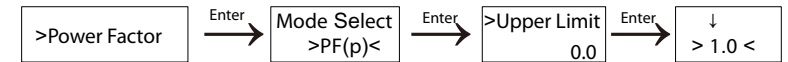

(4) P(u) Function: The device is suitable for Australia if the “Enable” is chosen.

(5) Power limits: User can set the power limit value of the inverter, and the default is 1. If you want to change, please refer to the method bellow. (the same operation to other setting value)



→The way to set value :  
 a) Long press the key (V) to enter the interface, and long press again to modify .  
 b) Short Press (A) or (V) to increase or decrease the value you needed.  
 c) After setting, long press the (V) key to confirm the parameters or you can long press the (A) to confirm and return the previous directly.

(6) Export Control: With this function the inverter can control energy exported to the grid. Whether having this function is based on user’s wishes.

Choose “Enable” in Mode Select means user must install a meter to monitor energy exported to the grid. There are user value and factory value. The factory value is default which can not be changed by user. The user value setting by installer must be less than the factory value and within the range of 0KW to 6KW.

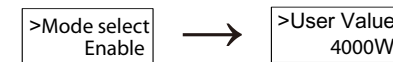

Choose “Disable” means the function will be shut off.

(7) Earth Detect: The default is “Disabled”. If turned on, the inverter will occur an error

(8) DRM Function: User can choose whether using the DRM function or not.

(9) New Password: Installer can set the new password here.

→The way to set password:

- a) Long press the key (V) to enter the interface, and long press again to modify.
- b) Short Press (Λ) or (V) to increase or decrease the value you needed.
- c) After setting, long press the (V) key to confirm the parameters.
- d) Long press (Λ) to enter next level.

(10) Reset Errorlog: The user can clear the errorlogs by this function.

(11) Reset Energy: The user can clear the power energy by this function.

(12) Reset Meter : The user can clear the Meter energy by this function.

(13) Line Impedance: User can choose whether using the Line Impedance function or not. It can reduce the protection of the false voltage caused by the high impedance.

(14) Self Test(only for CEI 0-21): User can test operating staus of inverter by choosing "All Test". When testing OK, the inverter will restart again and user can see the result from the "Test Report".

(15) About: This interface shows information of the inverter, including product serial number, machine type, master, slave, manager and internal code.

## 7 Troubleshooting

### 7.1 Troubleshooting

This section contains information and procedures for solving possible problems with X1 series inverters, and provides you with troubleshooting tips to identify and solve most problems that could occur with the X1 series inverters.

This section will help you narrow down the source of any problems you may encounter. Please read the following troubleshooting steps.

Check warnings or fault messages on System Control Panel or Fault codes on the inverter information panel. If a message is displayed, record it before doing anything further.

Attempt the solution indicated in troubleshooting lists.

- If your inverter's information panel is not displaying a Fault light, check the following list to make sure that the present state of the installation allows proper operation of the unit.
  - Is the inverter located in a clean, dry, adequately ventilated place?
  - Have the DC input breakers been opened?
  - Are the cables adequately sized and short enough?
  - Are the input and output connections and wiring in good condition?
  - Are the configurations settings correct for your particular installation?
  - Are the display panel and the communications cable properly connected and undamaged?

Contact SolaX Customer Service for further assistance. Please be prepared to describe details of your system installation and provide model and serial number of the unit.

Faults	Diagnosis and solution
SPI Fault	SPI communication fault <ul style="list-style-type: none"> <li>• Disconnect PV+ , PV-, reconnect them.</li> <li>• Or seek help from us, if can not go back to normal state.</li> </ul>
SCI Fault	SCI communication fault <ul style="list-style-type: none"> <li>• Disconnect PV+ , PV-, reconnect them.</li> <li>• Or seek help from us, if can not go back to normal state.</li> </ul>
PV Config Fault	PV Connection Setting Fault <ul style="list-style-type: none"> <li>• Resetting the PV connection</li> <li>• Or seek help from us, if can not go back to normal state.</li> </ul>
Inv EEPROM Fault	Inverter EEPROM fault <ul style="list-style-type: none"> <li>• Disconnect PV+ , PV-, reconnect them.</li> <li>• Or seek help from us, if can not go back to normal state.</li> </ul>
Relay Fault	Relay Fault <ul style="list-style-type: none"> <li>• Disconnect PV+ , PV-, reconnect them.</li> <li>• Or seek help from us, if can not go back to normal state.</li> </ul>
Sample Fault	The detection circuit Fault <ul style="list-style-type: none"> <li>• Disconnect PV+ , PV-, reconnect them.</li> <li>• Or seek help from us, if can not go back to normal state.</li> </ul>
RCD Fault	Residual Current Device Fault <ul style="list-style-type: none"> <li>• Check the impedance of DC input and AC output.</li> <li>• Disconnect PV+ , PV-, reconnect them.</li> <li>• Or seek help from us, if can not go back to normal state.</li> </ul>
AC HCT Fault	AC Current Sensor Fault <ul style="list-style-type: none"> <li>• Disconnect PV+ , PV-, reconnect them.</li> <li>• Or seek help from us, if can not go back to normal state.</li> </ul>
TZ Protect Fault	Over current Fault. <ul style="list-style-type: none"> <li>• Wait for a while to check if go back to normal status.</li> <li>• Disconnect PV+ , PV-, reconnect them.</li> <li>• Or seek help from us, if can not go back to normal state.</li> </ul>
Grid Lost Fault	Grid is Lost. <ul style="list-style-type: none"> <li>• System will reconnect if the utility is back to normal.</li> <li>• Or seek help from us.</li> </ul>
Grid Volt Fault	Grid Voltage Out of Range <ul style="list-style-type: none"> <li>• System will reconnect if the utility is back to normal.</li> <li>• Or seek help from us.</li> </ul>
Grid Freq Fault	Grid Voltage out of range <ul style="list-style-type: none"> <li>• System will reconnect if the utility is back to normal.</li> <li>• Or seek help from us.</li> </ul>
PLL Lost Fault	The Grid is Not Good. <ul style="list-style-type: none"> <li>• System will reconnect if the utility is back to normal.</li> <li>• Or seek help from us.</li> </ul>

Faults	Diagnosis and solution
Bus Volt Fault	Bus Voltage out of Normal Range. <ul style="list-style-type: none"> <li>• Disconnect PV+ , PV-, reconnect them.</li> <li>• Check if the PV input is within the range of the inverter.</li> <li>• Or seek help from us, if can not go back to normal state.</li> </ul>
Inv OCP Fault	Inverter over current protection fault <ul style="list-style-type: none"> <li>• Wait for a while to check if back to normal.</li> <li>• Or seek for help from us.</li> </ul>
DCI OCP Fault	DCI over current protection Fault. <ul style="list-style-type: none"> <li>• Wait for a while to check if back to normal.</li> <li>• Or seek for help from us.</li> </ul>
PV Volt Fault	PV Voltage Fault <ul style="list-style-type: none"> <li>• Check the output of the PV voltage.</li> <li>• Or seek for help from us.</li> </ul>
Isolation Fault	Isolation Fault <ul style="list-style-type: none"> <li>• Check the connection of the inverter.</li> <li>• Or seek for help from us.</li> </ul>
Temp Over Fault	Temperature over the limitation <ul style="list-style-type: none"> <li>• Check if the fan is running normally.</li> <li>• Check if the environment temperature is over limitation.</li> <li>• Or seek help from us.</li> </ul>
RC Fault	DCI over current protection Fault. <ul style="list-style-type: none"> <li>• Wait for a while to check if back to normal.</li> <li>• Or seek for help from us.</li> </ul>
Other device Fault	Other device fault. <ul style="list-style-type: none"> <li>• Turn off the PV and grid, reconnect them,</li> <li>• Or seek for help from us if can not back to normal.</li> </ul>
SW OCP Fault	Over current fault detected by software. <ul style="list-style-type: none"> <li>• Turn off the PV and grid, reconnect them,</li> <li>• Or seek for help from us if can not back to normal.</li> </ul>
Mgr EEPROM Fault	Manager EEPROM Fault. <ul style="list-style-type: none"> <li>• Turn off the PV and grid, reconnect them,</li> <li>• Or seek for help from us if can not back to normal.</li> </ul>
AC10M Volt Fault	AC10Minute overvoltage Fault <ul style="list-style-type: none"> <li>• System will reconnect if the utility is back to normal.</li> <li>• Or seek help from us.</li> </ul>
Meter Fault	Meter Fault <ul style="list-style-type: none"> <li>• Check the Meter connection with the inverter.</li> <li>• Or seek help from us.</li> </ul>
Earth Fault	Earth Fault <ul style="list-style-type: none"> <li>• Check the connection of the inverter.</li> <li>• Or seek help from us.</li> </ul>

## 7.2 Routine Maintenance

Inverters do not need any maintenance or correction in most condition, but if the inverter often loses power due to overheating, this can be the following reason:

- The cooling fins on the rear of house are covered by dirt.

Clean the cooling fins with a soft dry cloth or brush if necessary.

Only trained and authorized professional personnel who are familiar with the requirements of safety was allowed to perform servicing and maintenance work.

### ► Safety checks

Safety checks should be performed at least every 12 months by manufacturer's qualified person who has adequate training, knowledge, and practical experience to perform these tests. The data should be recorded in an equipment log. If the device is not functioning properly or fails any of test, the device has to be repaired. For safety check details, refer to this manual, section 2 Safety instruction and EC Directives.

### ► Maintain periodically

Only qualified person may perform the following works.

During the process of using the inverter, the manage person shall examine and maintain the machine regularly. The concrete operations are follow.

1) Check that if the cooling fins on the rear of house are covered by dirt, and the machine should be cleaned and absorbed dust when necessary.

This work shall be check time to time.

2) Check that if the indicators of the inverter are in normal state, check if the keys of the inverter are in normal state, check if the display of the inverter is normal. This check should be performed at least every 6 months.

3) Check that if the input and output wires are damaged or aged. This check should be performed at least every 6 months.

4) You should get the inverter panels cleaned and their security checked at least every 6 months.

## 8 Decommissioning

### 8.1 Dismantling the Inverter

- Disconnect the inverter from DC Input and AC output.
- Wait for 5 minutes for de-energizing.
- Disconnect communication and optional connection wirings.
- Remove the inverter from the bracket.
- Remove the bracket if necessary.



#### **WARNING!**

Before dismantling the inverter, please be sure to disconnect the DC switch, and then unplug the PV and AC cables, otherwise it will lead to an electric shock hazard.

### 8.2 Packaging

If possible, please pack the inverter with the original packaging.

If it is no longer available, you can also use an equivalent carton that meets the following requirements.

- Suitable for loads more than 30 kg.
- With handle.
- Can be fully closed.

### 8.3 Storage and Transportation

Store the inverter in dry place where ambient temperatures are always between  $-25^{\circ}\text{C}$  -  $+60^{\circ}\text{C}$ . Take care of the inverter during the storage and transportation, keep less than 4 cartons in one stack.

When the inverter or other related components need to be disposed. Have it carried out according to local waste handling regulations. Please be sure to deliver wasted inverters and packing materials to certain site, which can assist relevant department to dispose and recycle.